

EVOLVE[®] Xany 2in1

Elegant outdoor antenna for digital and analog TV reception

V4 - 23/10



Introduction:

This is a special designed new concept antenna for digital indoor and outdoor analog and terrestrial HDTV broadcasting reception. It is the best solution for home reception and digital portable TV reception. Complete accessories for horizontal and vertical mounting are included. With the anti-UV and water proof housing, it can be used both indoor and outdoor.

Technical Data:

- Frequency Range: UHF470-698MHz
VHF: 88-230MHz
- Max. Output level: 100dB μ V
- Impedance: 75 Ω
- Noise Figure: \leq 3.5dB
- Power Supply: DC12V
- 5G Filter

Included in Package:

Before start your installation, please check the contents.

1. Antenna main unit
2. Table positioning base(optional)
3. Mounting accessories
4. Power adapter
5. Coaxial cable with amplifier

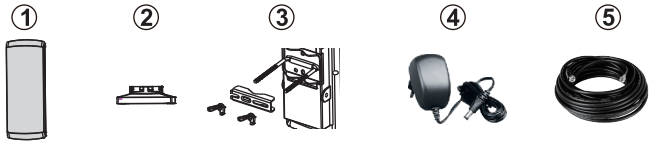

Product Features:

- Anti-UV coating and waterproof design.
- Lightweight, compact size and easy to install.
- For both analog and digital TV signal reception
- Built-in high gain and low noise preamplifier
- With dipole inbuilt for the excellent UHF and VHF band signal reception.
- Specially Compatible with HDTV of various digital terrestrial signal (DVB-T; ISDB-T; DMB-T/H; ATSC)

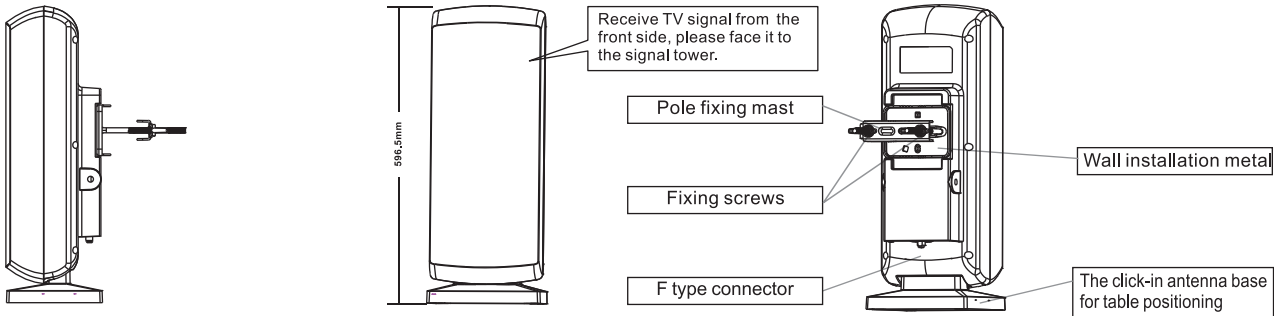

Mounting the antenna:

This antenna can be used both indoor and outdoor, with the included mounting accessories, it can be mounted on the pole.

(Fig.1) use the pole mounting accessories to fix the antenna on the pole

(Fig.2) use the mounting accessories to horizontal or vertical mount

Fig.1

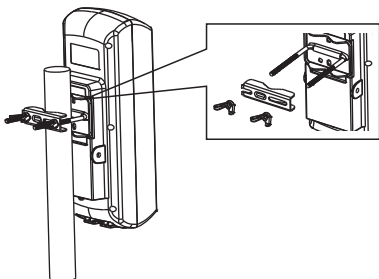
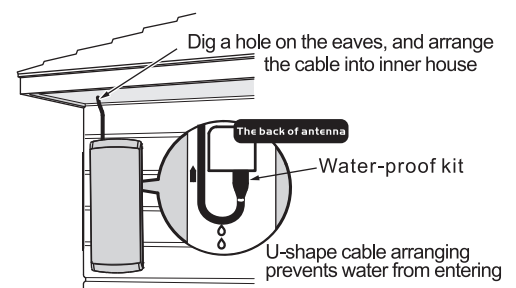
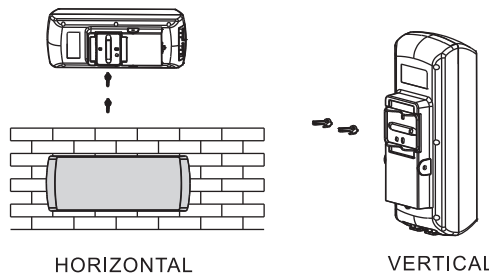
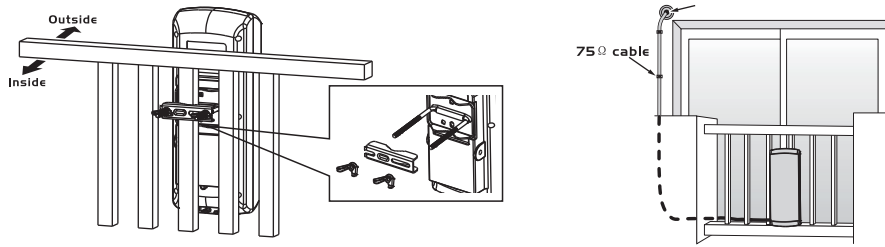

Fig.2

Using the screws to fix the antenna on the wall.



(Fig.3) Using the pole mounting accessories to fix the antenna on the balcony.



(Fig.4) Indoor installation (optional)

Note: Please take out the mounting accessories for indoor use.

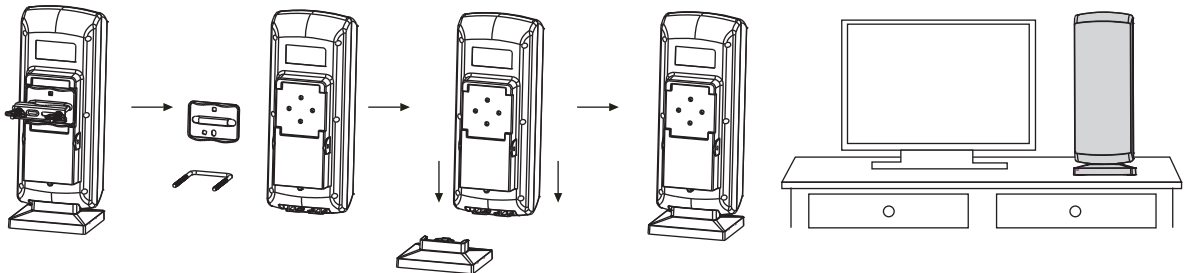

(Fig.5) connect the “F” male connector of the coaxial cable to the “F” female connector of the antenna, and wear the water-proof cap to the end of the connected “F” connector.

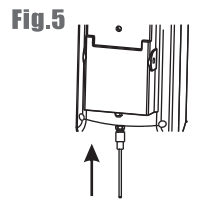

Installation: Please take following (Fig.6) and (Fig.7) installation instruction for reference.



Installation 1: Directly connected to TV(Fig.6)

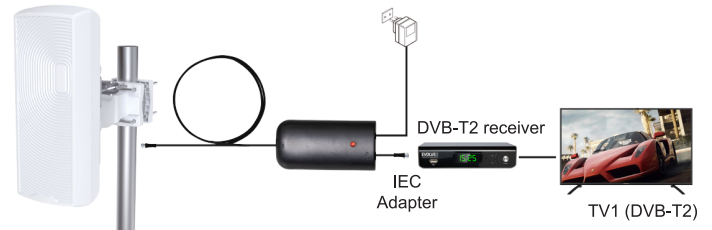

Installation 2: Connected through set-top box (Fig.7)

Note: After the antenna mounting and installation is finished, please adjust the antenna in the best position that can get clear TV picture, then fix the antenna, organize the coaxial cable for neat, tidy and safety, Please take reference of following positioning way to adjust the antenna position.

(Fig.8)through turning the antenna body to adjust the antenna position in left or right direction (indoor using)

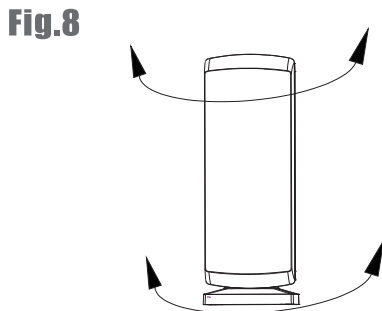

Operation Instruction:

- Note: For the best reception, Please check the following conditions
1. Keep the antenna away from the sources of interference: keep the antenna away from those big power consumption devices, such as air conditioner, elevator, hair dryer and microwave oven...etc.
 2. Place the antenna near windows when use the antenna in indoor environment.
 3. Install the antenna as high as possible: in digital terrestrial reception, if there are some interceptions between antenna and transmission tower, it will cause the signal loss temporarily. So if the antenna is installed as possible, those interceptions will be reduced.

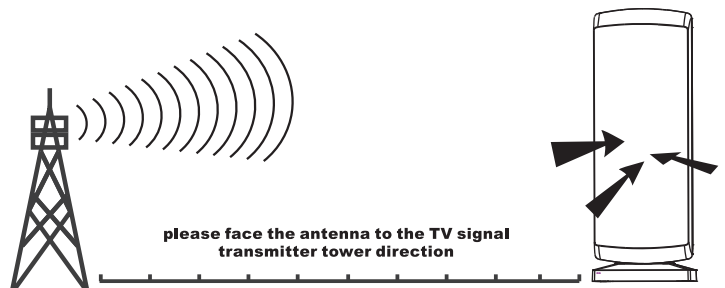



Disposal: The symbol of crossed out container on the product, in the literature or on the wrapping means that in the European Union all the electric and electronic products, batteries and accumulators must be placed into the separate salvage after finishing their lifetime. Do not throw these products into the unsorted municipal waste



DECLARATION OF CONFORMITY

Hereby, the company Abacus Electric, s.r.o. declares that the EVOLVEO Xany 2in1 is in compliance with the requirements of the standards and regulations, relevant for the given type of device.

Find the complete text of Declaration of Conformity at <http://ftp.evolveo.com/ce/>

Dovozce / Výrobce - Dovozca / Výrobca - Importer / Manufacturer - Importőr / Gyártó
Abacus Electric, s.r.o.
Planá 2, 370 01, Czech Republic

Made in China

Copyright © Abacus Electric, s.r.o.
www.evolveo.com
www.facebook.com/EvolveoCZ

All rights reserved.
Design and specification may be changed without prior notice.